

Indac Tool Boxes

These ultra tough, sturdy utility boxes are built strong to take the knocks and keep coming back for more.

Weatherproof, lockable, fitted with stainless steel latches, covered by a 5 year warranty and available in a range of sizes and colours, INDAC'S robust tool boxes are an essential addition for the serious tradesman.



5 BIG SIZES

TMC400	400 (w) x 250 (d) x 300 (h)mm
TMC600	600 (w) x 300 (d) x 300 (h)mm
TMC900	900 (w) x 500 (d) x 400 (h)mm
TMC1200	1200 (w) x 600 (d) x 490 (h)mm
TMC1600	1600 (w) x 600 (d) x 550 (h)mm

Standard colours: Black, Mid Blue, Grey, Red, Yellow, Dark Green

Range of sizes for all applications



Essential to carry all your tools



FREEPHONE
0800 803 888

www.indac.nz

Email info@indac.co.nz

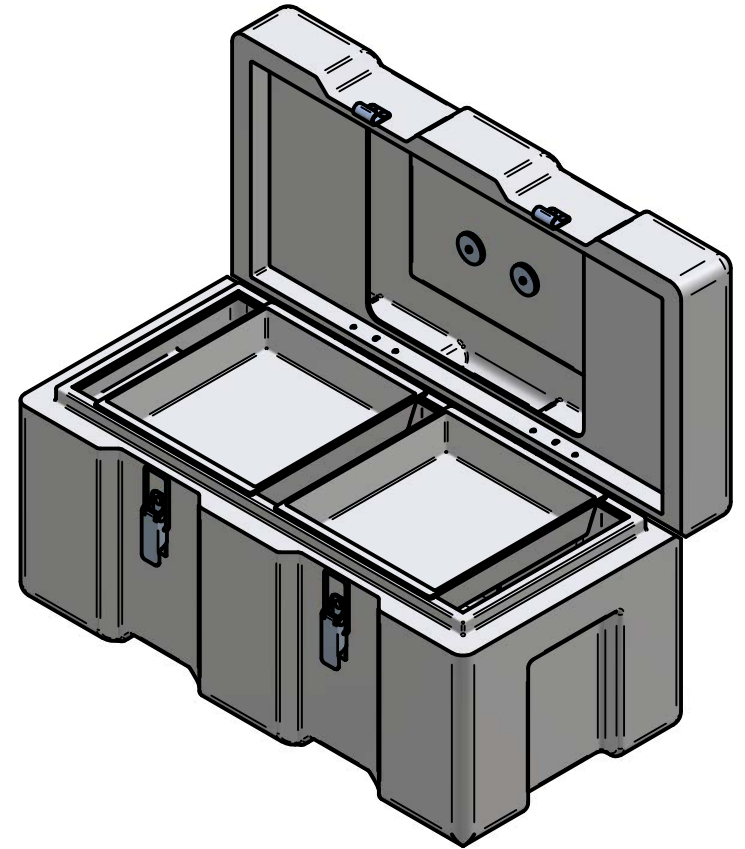
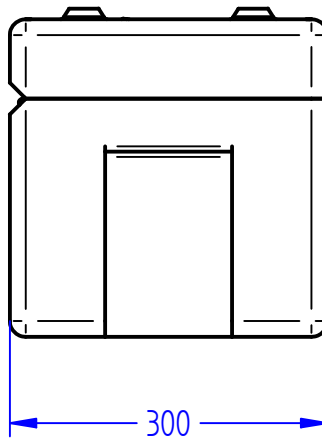
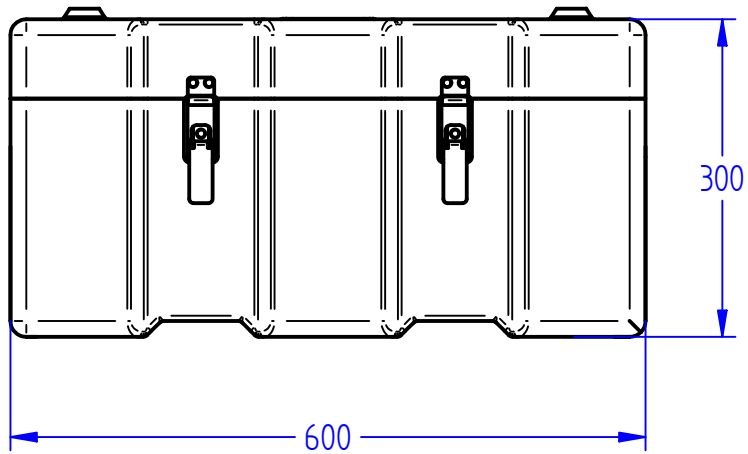

Product name: MC600 Toolbox

Product code: TMC600

COPYRIGHT RESERVED

All dimensions and weights are nominal

FILE NAME: MC600 Toolbox.dft

INDAC
INNOVATIVE DESIGN AND CONSTRUCTION

Box 378
26 Stuart Street
Blenheim, 7201

Phone: +64 3 578 3034
www.indac.co.nz
www.plasticproducts.co.nz